

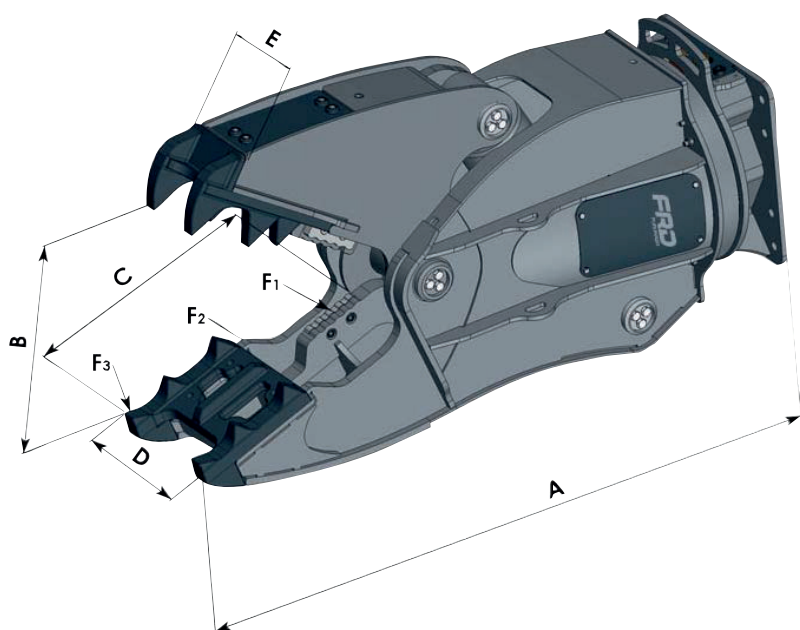







FURUKAWA - VM25ER



Specificaties		VM25ER
A	mm	2570
B	mm	930
C	mm	940
D	mm	454
E	mm	290
F1	kN	2600
F2	kN	1380
F3	kN	1050
	mm	200
	l/min	30
	bar	120
	l/min	250 - 300
	bar	350
	kg	2489
	t	22 - 30

